

SAVINGS SPOTLIGHT

Prices Effective May 1 - June 30, 2009

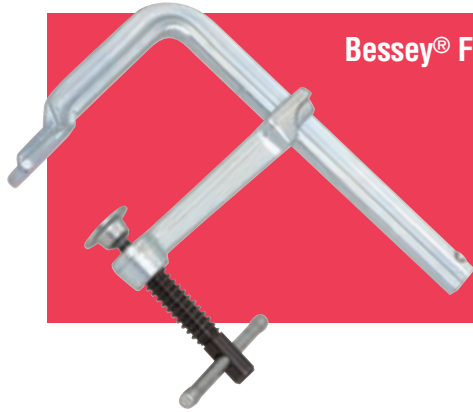

Bessey® F-Style Clamps
As Low As
\$24.99
Page 3



MiraCool® Bandanas
Only
\$2.19
Page 15

Fast Orange® Hand Cleaner
Only
\$15.99
Page 9



DYKEM

Jet Guard Safety Air Gun
Only
\$15.99
Page 11



JET GUARD AIR

Machinist Clamping Kit
Only
\$45.99
Page 4



Manual Controls - Knobs, Handles and Handwheels

Clamps and Workholding

Tooling Components

Fasteners and Hardware

Leveling Devices and Vibration Control

Material Handling

Bearings and Power Transmission

Metalworking

Maintenance, Repair and Operations (MRO)

Pneumatics and Hydraulics

Structural Systems

Safety

TOOL-UP with Reid

We offer Industrial Products
in 12 Categories plus
FREE CAD at **ReidSupply.com**

- Manual Controls - Knobs, Handles and Handwheels
- Clamps and Workholding
- Tooling Components
- Fasteners and Hardware
- Leveling Devices and Vibration Control
- Material Handling
- Bearings and Power Transmission
- Metalworking
- Maintenance, Repair and Operations
- Pneumatics and Hydraulics
- Structural Systems
- Safety

Find the parts you need — **FAST**
at **ReidSupply.com!**

Drill down to the exact part you need with just a few clicks using our Smart Search and QuickNav technology.

New CAD Search

Smart Search
 Product CAD

Find your **FREE CAD drawings** now with the same Smart Search technology as our product search.

Browse Our **NEW**
Clearance
Section



Look for the
Red Tag & Save BIG
...up to 90% Off!

Attention GSA Customers

Note: This flier contains open market products, in addition to those included on the Reid Supply scheduled contract. Call **888.472.7343** today to see if you qualify for special pricing.



Contract Holder
FSS Contract GS-06F-0095S

VERTICAL HANDLE HOLD-DOWN CLAMPS

Series TC-2002, 2007, 2010

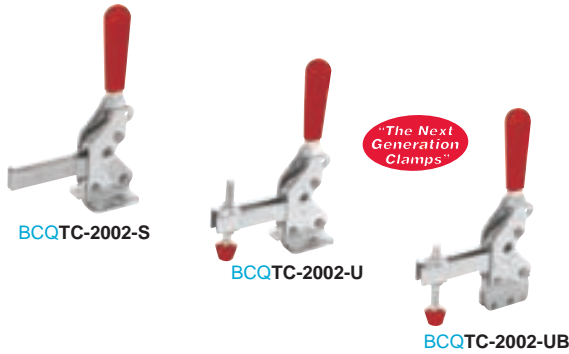

Sale Price
As Low As
\$11.99

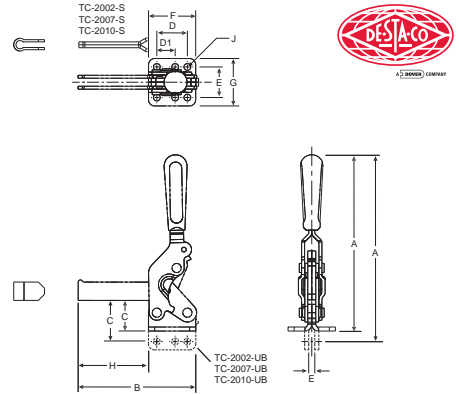

Now you can save valuable space in all your applications without sacrificing holding capacity or clamp performance. The open "U" bar has a knob on the end to prevent the spindle from slipping off the end of the arm. Unique design delivers greater hand clearance in the open position, eliminating pinch points and improving safety and ergonomics. Clamp comes complete with ergonomic handle grip, two flanged washers and spindle assembly ("U" bar models only). All "S" bar models supplied with bolt retainer.

Cat. No.	A	B	C	D	D1	E	F	G	H	J	Handle Moves	Bar Opens	Holding Capacity Lbs.	Sale Price Each
BCQTC-2002-S	4.73	3.29	.95	.90	.50	1.06	1.36	1.52	1.93	.22	85	71	600	12.49
BCQTC-2002-U	4.73	3.29	.95	.90	.50	1.06	1.36	1.52	1.93	.22	85	71	600	11.99
BCQTC-2002-UB	5.07	3.29	1.27	.90	.50	.25	1.36	—	1.93	.22	85	71	600	12.99
BCQTC-2007-S	7.21	4.81	1.25	1.25	.75	1.25	1.93	1.94	2.88	.28	76	65	1000	15.99
BCQTC-2007-U	7.21	4.81	1.25	1.25	.75	1.25	1.93	1.94	2.88	.28	76	65	1000	15.49
BCQTC-2007-UB	7.64	4.81	1.68	1.25	.75	.25	1.93	—	2.88	.28	76	65	1000	15.99
BCQTC-2010-S	9.00	6.09	1.70	1.25	—	1.78	2.53	2.62	3.56	.34	83	69	1400	21.99
BCQTC-2010-U	9.00	6.09	1.70	1.25	—	1.78	2.53	2.62	3.56	.34	83	69	1400	21.99
BCQTC-2010-UB	9.612	6.09	2.20	1.25	—	316	2.53	—	3.56	.34	83	69	1400	22.99

BESSEY® F-STYLE

All Steel Bar Clamps

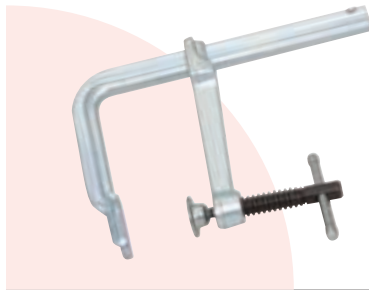

Sale Price
As Low As
\$24.99

Easy to use. Slide moveable arm into position and tighten screw spindle. Provides instant clamping at any opening. Saves time over ordinary C-clamps. Deep throat allows for greater reach.

Cat. No.	Jaw Opening	Throat Depth	Spindle Dia.	Clamp Pressure	Sale Price Each
Regular Duty					
BCQBLC-15	0-4	4¾	.563	1,330	24.99
Heavy Duty					
BCQBLC-25	0-8	5½	.775	2,600	46.99
BCQBLC-50	0-12	5½	.775	2,600	64.99
BCQBLC-60	0-20	5½	.775	2,600	79.99
Extra Heavy Duty					
BCQBLC-70	0-12	7	.850	4,880	129.99
BCQBLC-80	0-18	7	.850	4,880	149.99
BCQBLC-90	0-36	7	.850	4,880	189.99

PRESSURE ADJUSTING SPRING CLAMPS

Allows pressure adjustment from 1 to 50 pounds of clamping force. The jaws and handles are made of glass filled nylon. Springs are heavy duty tempered steel. Soft, pivoting, plastic jaw pads to hold irregular shaped objects.



Sale Price
As Low As
\$2.99

Cat. No.	Jaw Opening	Jaw Length	Jaw Reach	Sale Price Each
BCQAC-3251	1	4½	1¼	2.99
BCQAC-3252	2	6½	2⅞	3.99

FIXTURE CLAMPS

Save
10%

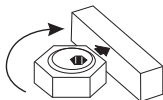

The Mitee-Bite™ clamping system combines strength, versatility and performance with economy and ease of use. Consisting of a cam action socket cap screw with a brass hex washer, set ups are simplified even for hard to hold parts. Its small size allows more parts per load on multiple series jobs. The low profile makes programming easier because there are no clamps to jump over. Fast to use (just 1/4 turn of screw loosens clamp) and no loose parts to set up each time. Economical— all six sides of the hex nut can be used. Available in six sizes for use on multiple part fixtures. Metric sizes are in millimeters. MB-10203 and MB-50207 are stainless steel.

Cat. No.	Screw Size	Thread Lgth.	Hex Size	Hex Ht.	Max. Holding Force Lbs.	Total Throw	No. of Clamps Per Pkg.	Sale Price Per Pkg.
Inch								
BCQMB-2	8-32	350	.312	.110	205	.030	10	45.63
BCQMB-3	10-32	340	.500	.160	350	.040	10	48.02
BCQMB-4	¼-20	.470	.625	.190	800	.040	10	48.02
BCQMB-10203*	¼-20	.470	.625	.190	—	.040	4	51.71
BCQMB-5	5/16-24	.460	.812	.190	750	.040	12	60.17
BCQMB-5C	5/16-18	.460	.812	.190	750	.040	12	60.17
BCQMB-6	3/8-16	.710	.812	.250	2,000	.050	10	55.35
BCQMB-8	½-13	900	1.000	.375	4,000	.100	8	60.17
Metric								
BCQMB-50204	M4	9.6	7.93	2.80	93	.76	10	45.63
BCQMB-50206	M6	11.2	15.86	4.75	364	1.01	10	48.02
BCQMB-50208	M8	15.0	20.61	4.75	340	1.01	12	60.17
BCQMB-50207*	M8	15.0	20.60	6.35	—	1.01	4	69.26
BCQMB-50210	M10	19.0	20.61	6.35	910	1.52	10	55.35
BCQMB-50212	M12	22.8	25.38	9.52	1,818	2.03	8	60.17
BCQMB-50216	M16	28.5	30.13	12.69	2,720	2.54	4	45.63

*Stainless steel

MACHINIST CLAMPING KIT

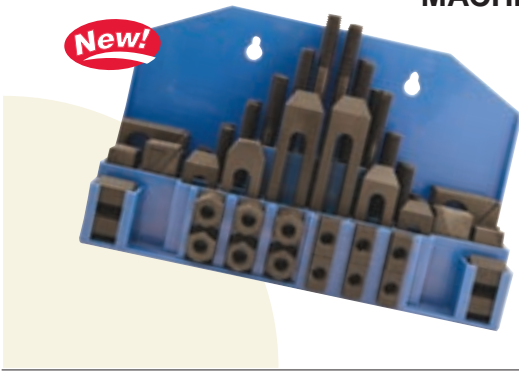

New!

Sale Price
Only
\$45⁹⁹

Kit includes:

- Six T-slot nuts
- Four coupling nuts
- Six serrated end clamps
- 12 step block halves
- 1 plastic
- 24 studs - four each of 3", 4", 5", 6", 7", and 8" lengths

Cat. No.	Description	Sale Price Each
BCQSUS-22200	58 Piece Machinist Clamping Kit	45.99

T AND L PINS

T-Pins and L-Pins are designed to be used as a removable locating device for precision alignment of work piece in jigs and fixtures. Heat treated steel. Black oxide finish.

T-Pin Cat. No.	L-Pin Cat. No.	+.000/-0.0005					Sale Price Each
		A	B	C	D		
BCQPNT-1	BCQPNL-1	.1250	2 1/2	1 1/2	1/4		2.79
BCQPNT-2	BCQPNL-2	.1875	3	2 1/2	5/16		2.80
BCQPNT-3	BCQPNL-3	.1875	3	2 1/2	5/16		2.94
BCQPNT-7	BCQPNL-7	.2500	6	2 1/2	3/8		3.29
BCQPNT-8	BCQPNL-8	.2500	4	2 1/2	3/8		3.35
BCQPNT-9	BCQPNL-9	.2500	6	2 1/2	3/8		3.49
BCQPNT-11	BCQPNL-11	.3125	3 1/2	3	7/16		3.98
BCQPNT-12	BCQPNL-12	.3125	6	3	7/16		4.10
BCQPNT-13	BCQPNL-13	.3750	4	3 1/2	1/2		4.38
BCQPNT-14	BCQPNL-14	.3750	6	3 1/2	1/2		4.64
BCQPNT-15	BCQPNL-15	.4375	4	3 1/2	9/16		4.64
BCQPNT-16	BCQPNL-16	.4375	6	3 1/2	9/16		5.45
BCQPNT-17	BCQPNL-17	.5000	4	3 1/2	5/8		5.45
BCQPNT-18	BCQPNL-18	.5000	6	3 1/2	5/8		6.36
BCQPNT-19	BCQPNL-19	.5625	4	3 1/2	5/8		6.70
BCQPNT-21	BCQPNL-21	.6250	6	3 1/2	7/8		8.55
BCQPNT-22	BCQPNL-22	.7500	6	3 1/2	7/8		9.58

Note: Steel cable assemblies available. See page 289 of our 2009 Full Line Catalog.

Bold catalog numbers conform to TCMAI standards.

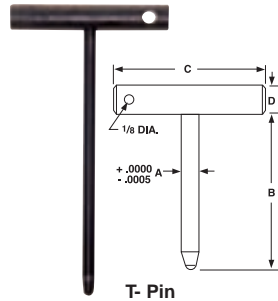

T-Pin

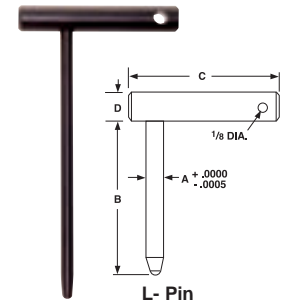

L-Pin

Sale Price
As Low As
\$2⁷⁹

JIG PINS

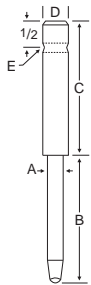

W/O Handle

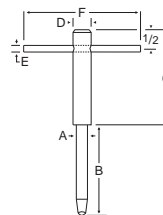

W/Handle



Save
10%

Used for accurately aligning holes on mating pieces. Black oxide finish. Handle version converts to T or L handle.

w/o Handle Cat. No.	w/ Handle Cat. No.	+.0000 -.0005					Sale Price Each		
		A	B	C	D	E	F	w/o Handle	w/ Handle
BCQJGP-110	BCQJGP-210	.2500	2.5	2 5/8	1/2	1/4	2	6.32	8.94
BCQJGP-120	BCQJGP-220	.3125	2.5	2 5/8	9/16	1/4	3	6.70	9.19
BCQJGP-130	BCQJGP-230	.3750	4.0	2 5/8	5/8	1/4	3	8.16	10.46
BCQJGP-140	BCQJGP-330	.5000	3.0	2 5/8	3/4	5/16	3	8.61	11.75

CLAMPING PINS

Sale Price
As Low As
\$5⁴⁹

Usually used for clamping materials of various thicknesses. Adjust the bushing at the proper length and weld into position. Black oxide finish.

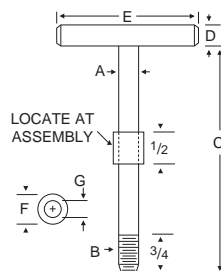

LOCATE AT ASSEMBLY



Cat. No.	A	B	C	D	E	F	G	Sale Price Each
BCQJGP-006	.249	1/4-20	4.0	.3750	2.5	1/2	.252	5.49
BCQJGP-009	.312	5/16-18	4.0	.4375	3.0	9/16	.315	5.49
BCQJGP-021	.624	5/8-11	5.5	.8750	3.5	7/8	.628	8.07

LIFTING HOOKS

Swivel & Pivot
Inch and Metric



Save
More Than
15%

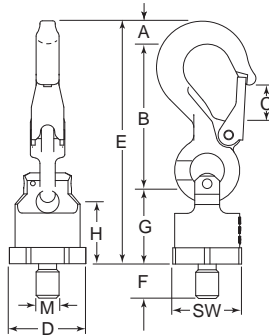

Full swivel and 180° pivot with double ball bearings for smooth tilting, twisting and turning, all without jerking of the lifting point. Suitable for all sling systems, either hook, eye or loop. Has non-protruding hook tip and is extremely durable. Special design hook top. Forged safety latch which engages in the top of hook therefore, protected against lateral bending. Coiled double leg spring in stainless steel protected by latch design. Wearing edges on both sides. Gauge marks for measuring the opening (width) of hook.

IMPORTANT NOTE: All lifting points have a proprietary fluorescent powder coat finish. By changing its color, the finish permanently shows the temperature to which the lifting point has been exposed. When this color change occurs, the lifting device should be replaced immediately.

Note: Torque hand tight with spanner.

Cat. No.	Bolt Size	WLL (Lbs.)	A	B	C	D	E	F	G	H	M	SW	Sale Price Each
Inch													
BCQPPS-11	1/2-13	1,385	1/2	2 ¹⁵ / ₁₆	2 ³ / ₃₂	1 ⁹ / ₁₆	4 ⁹ / ₁₆	2 ³ / ₃₂	1 ⁵ / ₈	1 ¹ / ₃₂	1/2	1 ¹³ / ₃₂	136.25
BCQPPS-12	5/8-11	3,300	1 ³ / ₁₆	3 ¹³ / ₁₆	1	1 ¹³ / ₁₆	5 ³ / ₄	1	1 ³¹ / ₃₂	1 ⁹ / ₁₆	5/8	1 ⁵ / ₈	169.55
BCQPPS-13	3/4-10	5,500	1 ⁷ / ₆₄	4 ³¹ / ₃₂	1 ³ / ₁₆	2 ¹³ / ₃₂	7 ²³ / ₆₄	1 ³ / ₁₆	2 ¹³ / ₃₂	1 ¹⁵ / ₁₆	3/4	2 ⁵ / ₃₂	215.37
BCQPPS-14	1-8	8,800	1 ¹³ / ₃₂	5 ²⁹ / ₃₂	1 ³ / ₈	3 ⁵ / ₆₄	8 ¹⁵ / ₁₆	1 ¹³ / ₃₂	3 ¹ / ₃₂	2 ⁷ / ₁₆	1	2 ³ / ₄	302.51
BCQPPS-15	1 1/4-7	11,000	1 ¹⁵ / ₃₂	6 ⁷ / ₈	1 ⁹ / ₁₆	3 ³ / ₄	10 ¹ / ₂	1 ³ / ₄	3 ² / ₃₂	3 ¹ / ₃₂	1 1/4	3 ¹¹ / ₃₂	438.75
BCQPPS-16	1 1/2-6	17,600	1 ¹⁵ / ₁₆	8 ³ / ₁₆	1 ¹³ / ₁₆	3 ¹⁵ / ₁₆	12 ¹³ / ₆₄	2 ¹ / ₈	4 ¹ / ₆₄	3 ⁵ / ₁₆	1 1/2	3 ⁹ / ₁₆	693.17
Metric													
BCQPPS-17	M12x1.75	0.63	13	75	18	40	116	18	41	34	12	36	127.00
BCQPPS-18	M16x2.0	1.5	20	97	25	46	147	25	50	40	16	41	160.09
BCQPPS-19	M20x2.5	2.5	28	126	30	61	187	30	61	50	20	55	200.98
BCQPPS-20	M24x3.0	4.0	36	150	35	78	227	36	77	62	24	70	282.37
BCQPPS-21	M30x3.5	5.0	37	174	40	95	267	45	93	77	30	85	412.05

SLINGS

Tuflex®
Endless Round Slings



**Sale Price
As Low As
\$11.99**



Vertical



Choke



Basket

Round slings have a double wall cover for greater life and added protection. Wear points can be shifted to extend life of the sling. Chokes tighter and releases easier than other slings. Color coded for rated capacity. Has red core warning yarn inspection system.

Cat. No.	Color	Rated Capacities (lbs.)			Length (Ft.)	Sale Price Each
		Vertical	Choke	Basket		
BCQLIF-41	Purple	2,600	2,100	5,200	4	11.99
BCQLIF-42	Purple	2,600	2,100	5,200	6	16.31
BCQLIF-43	Purple	2,600	2,100	5,200	8	20.75
BCQLIF-44	Purple	2,600	2,100	5,200	10	25.22
BCQLIF-45	Purple	2,600	2,100	5,200	12	29.66
BCQLIF-46	Green	5,300	4,200	10,600	4	14.37
BCQLIF-47	Green	5,300	4,200	10,600	6	20.23
BCQLIF-48	Green	5,300	4,200	10,600	8	26.09
BCQLIF-49	Green	5,300	4,200	10,600	10	31.94
BCQLIF-50	Green	5,300	4,200	10,600	12	37.80
BCQLIF-51	Yellow	8,400	6,700	16,800	4	19.09
BCQLIF-52	Yellow	8,400	6,700	16,800	6	26.98
BCQLIF-53	Yellow	8,400	6,700	16,800	8	34.88
BCQLIF-54	Yellow	8,400	6,700	16,800	10	42.77
BCQLIF-55	Yellow	8,400	6,700	16,800	12	50.66
BCQLIF-56	Red	13,200	10,600	26,400	4	28.28
BCQLIF-57	Red	13,200	10,600	26,400	6	40.00
BCQLIF-58	Red	13,200	10,600	26,400	8	51.72
BCQLIF-59	Red	13,200	10,600	26,400	10	63.45
BCQLIF-60	Red	13,200	10,600	26,400	12	75.17
BCQLIF-61	Blue	21,200	17,000	42,400	4	43.58
BCQLIF-62	Blue	21,200	17,000	42,400	6	62.69
BCQLIF-63	Blue	21,200	17,000	42,400	8	81.78
BCQLIF-64	Blue	21,200	17,000	42,400	10	100.88
BCQLIF-65	Blue	21,200	17,000	42,400	12	119.97

Adjust-A-Link™
Adjustable Chain Slings



The most easily adjustable and versatile chain sling available. Ideal for machine shop or maintenance departments. Made with grade 80 alloy chain. Proof tested and certified to comply with OSHA.

Cat. No.	Chain Size	Rate Capacities (lbs.)		Length (Ft.)	Sale Price Each
		Single @ 90	Double @ 60		
BCQLIF-95	7/32	2,100	3,600	6	149.99
BCQLIF-96	7/32	2,100	3,600	10	180.69
BCQLIF-97	9/32	3,500	6,100	6	185.05
BCQLIF-98	9/32	3,500	6,100	10	216.65
BCQLIF-99	3/8	7,100	12,300	10	349.49
BCQLIF-100	3/8	7,100	12,300	14	393.22
BCQLIF-101	1/2	12,000	20,800	10	424.33
BCQLIF-102	1/2	12,000	20,800	14	491.56

Sale Price
As Low As
\$149.99



Bearings and
Power Transmission

New and
replacement
motors for your
repair and new
equipment
needs.

20% Off All Motors

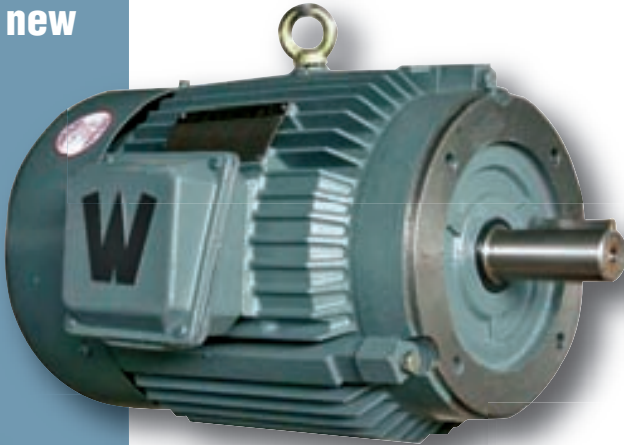

See Pages 420 - 426 of
Our Online Catalog at
ReidSupply.com

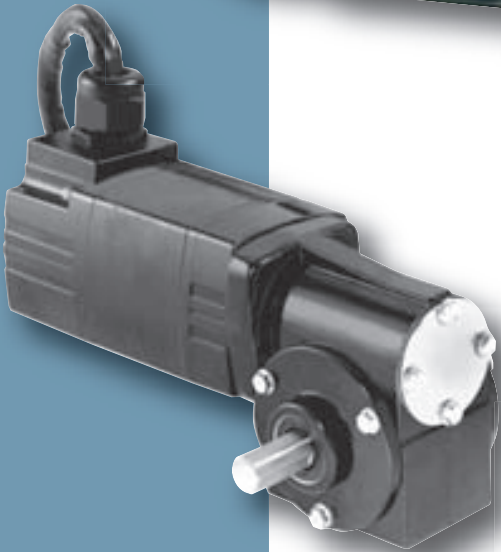

BODINE[®]
ELECTRIC
COMPANY

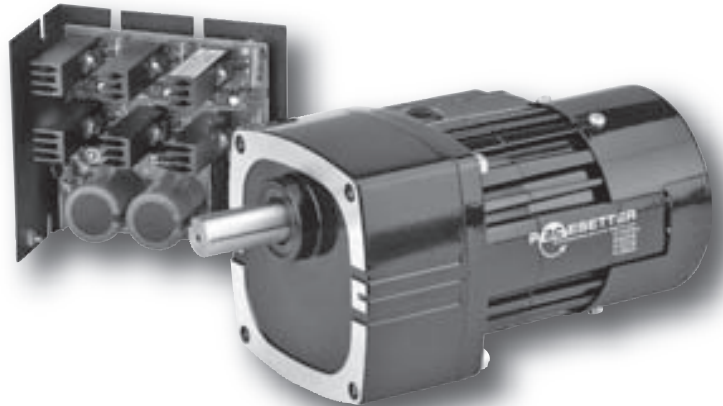

Nobody
Will Serve the Customer
Better!

PRECISION INSTRUMENTS

Fractional Digital Caliper



One year warranty

Sale Price
As Low As
\$19⁹⁹

- 3 readouts: fractional inch, decimal inch and mm
- Graduations: 1/128"/0.0005"/0.01 mm
- Zero setting at any position
- Big .5" (12 mm) high LCD display
- Enhanced stable display with quick sliding
- Instant SEA/metric conversion
- Includes fitted case with two batteries
- Full one year warranty

Cat. No.	Description	Range	Sale Price Each
BCQYPI-9	Caliper in Fitted Case	0-6" (0-150mm)	19.99
BCQYPI-10	Caliper in Fitted Case	0-8" (0-200mm)	29.99
BCQYPI-2	Replacement Battery		.99



6" Digital Micrometers



One year warranty

Sale Price
As Low As
\$59⁹⁹
Each

- Zero setting at any position
- Big .43" (11 mm) high LCD display
- Instant SAE/metric conversion
- Graduations: 0.0005"/0.01 mm
- Includes fitted case with two batteries
- Ratchet type, no output
- Full one year warranty

Cat. No.	Description	Range	Sale Price Each
BCQYPI-4	Digital Micrometer in Fitted Case	0-25mm	59.99
BCQYPI-5	Digital Micrometer in Fitted Case	25-50mm	79.99
BCQYPI-2	Replacement Battery		.99



GRINDING WHEELS

32A Surface Grinding Wheels
Best value in the toolroom



Save
More Than
10%
On Grinding
Wheels
Shown Here

- Type 1 straight and Type 5 recessed 1 side
- Color light grey
- Good for form holding
- Light to medium stock removal .001" - .003" per pass
- Industry proven and multi-purpose performance based
- Good for tool and die steels and difficult to grind materials

Cat. No.	Size	Type	Specification	Max. RPM	Sale Price Each
BCQRAD-A320697	7x1/ax1 1/4	1	32A60-J8-VEQ	3,600	16.83
BCQRAD-A320699	7x1/2x1 1/4	1	32A46-I8-VEQ	3,600	20.96
BCQRAD-A320706	7x1/2x1 1/4	1	32A60-K8-VEQ	3,600	20.96
BCQRAD-A320708	7x1/2x1 1/4	1	32A80-K8-VEQ	3,600	20.96
BCQRAD-A322147	8x1/ax1 1/4	1	32A80-K8-VEQ	3,600	20.27
BCQRAD-A329676	8x1/2x1 1/4	1	32A46-G8-VEQ	3,600	25.11
BCQRAD-A320710	8x1/2x1 1/4	1	32A46-H8-VEQ	3,600	25.11
BCQRAD-A322161	8x1/2x1 1/4	1	32A80-K8-VEQ	3,600	25.11
BCQRAD-A322181	12x1x3	1	32A60-I8-VEQ	2,070	74.03
BCQRAD-A325057	14x1 1/2x5	1	32A46-H8-VEQ	1,800	137.17

8BP Ceramic Surface Grinding Wheels
Best performance in the toolroom



Sale Price
As Low As
\$24⁹⁹

- Type 1 straight
- Color blue
- Longer wheel life
- Excellent for form holding
- Used for hard to grind materials
- Heavy stock removal .005" plus per pass
- Best for surface, cylindrical, tool and cutter grinding
- High performance ceramic made with 3M® Cubitron 321® grain
- Best for die steels and difficult to grind materials

Cat. No.	Size	Type	Specification	Max. RPM	Sale Price Each
BCQRAD-A329742	7x1/ax1 1/4	1	8BP60-J8-V8	3,600	24.99
BCQRAD-A323162	7x1/2x1 1/4	1	8BP46-J8-V8	3,600	31.44
BCQRAD-K323164	8x1/2x1 1/4	1	8BP46-H800-VOS	3,600	37.65
BCQRAD-A323169	8x1/2x1 1/4	1	8BP60-I8-V8	3,600	37.65
BCQRAD-K322836	12x1x3	1	8BP46-H800-VOS	2,070	111.08
BCQRAD-A323884	14x1x5	1	8BP46-I8-V8	1,800	148.71
BCQRAD-K323153	14x1 1/2x5	1	8BP46-H800-VOS	1,800	205.80

GRINDING CONCENTRATE



Sale Price
As Low As
\$39⁹⁹



Radiac 100 Metalworking Fluid is an extremely low-foaming synthetic designed to inh bit rust and prevent bacterial growth. Free of mineral oils, phenols, mercurials, phosphates, PCB's, nitrite and diethanolnitrosamine.

Cat. No.	Size	Specification	Sale Price Each
BCQRAD-7381957	1 Gallon	Pink	39.99
BCQRAD-7381958	5 Gallon	Pink	139.99

GRINDING WHEEL BUSHINGS

Bushings are
always **FREE** at
Reid Supply



Cat. No.	Inside Diameter	Outside Diameter	Thickness	Sale Price Each
BCQRAD-100	1/2	1 1/4	1/4	Free
BCQRAD-101	5/8	1 1/4	1/4	Free
BCQRAD-102	3/4	1 1/4	1/4	Free
BCQRAD-103	7/8	1 1/4	1/4	Free
BCQRAD-104	1	1 1/4	1/4	Free

Note: Bushings shown above are free with the purchase of Radiac Grinding Wheels only.

**Fasteners
and Hardware**



15% Off All Machine Screws

**Nobody Will Serve
the Customer Better!**

See Pages 242 - 244 of Our Online
Catalog at **ReidSupply.com**

Maintenance, Repair and Operations

REFERENCE BOOKS

Fastener's Black Book

Sale Price

Cat. No. **BCQDR-94**

Only

\$24⁹⁹

Reg. Price \$27.99



**FREE
Fastener Gauge With
Every Purchase!**

A pocket sized book that contains a wealth of up-to-date, useful, practical and hard to find information, over 200 pages. Every page is coated with a glare-free laminate that keeps pages from being torn and grease stained. Ideal for tool rooms, machine shops, fabricators, apprentices, technical trade colleges, industrial and fastener professionals and more. Fastener gauge supplied free with each book.

Engineer's Black Book

Sale Price

Cat. No. **BCQDR-95**

Only \$19⁹⁵

Reg. Price \$24.99

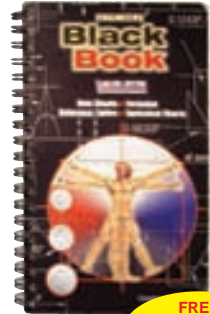

**FREE
Drill Gauge With
Every Purchase**

A pocket sized book that contains a wealth of up-to-date, useful, practical and hard to find information. Every page is coated with a glare-free laminate that keeps pages from being torn and grease stained. Ideal for tools rooms, machine shops, fabricators, apprentices, technical trade colleges, industrial and fastener professionals and more. Drill point sharpening gauge supplied free with each book.



MACHINIST'S CALCULATOR

Cat. No. **BCQTIS-MC-20**

Only \$38⁹⁵

Determine the best machine speed and feed rates for all tools and material accurately with complete portability. Modern high-speed equipment combined with vastly superior tools yield production and quality advantages like never before. The

machinist's calculator provides operators a hand-held device to determine startup parameters in the machine/tool/material equation. Achieve optimum production; minimize tool damage and wasted pieces. Built-in formulas return proper RPM, SFM, IPM, FPT, and CT (Cut Time) for all operations on all kinds of set-ups for machine, materials and tools. Calculator has prompting formats and yields time estimates. Perfect educational tool that fits in palm or pocket.



Great Value

**Buy All 3
and Save More**

Cat. No. **BCQDR-100**

Only \$76⁹⁹

**Save \$14.94
Over Regular Price**



SOCKET SETS

3/8" Drive Socket Set 6pt
15 Pieces



**Sale Price
Only
\$64⁹⁹**

New!

**Lifetime
guarantee**

**Many New Sets
Available at
ReidSupply.com**

KTT-A3504SR

KTT-A3504SR Contains one each of 3/16", 7/16", 1/2", 9/16", 5/8", 11/16", 3/4", 13/16", 7/8", 1" sockets, 3/8" female/1/2" male socket adapter, universal joint, 8" polished reversible ratchet, 3" and 6" extension bars. Plastic case. Easy grab "Grip Strips" on each socket - blue metric, red SAE.

KTT-A3504MR Contains one of each 9, 10, 11, 12, 13, 14, 15, 16, 17, 19mm sockets, 3/8" female/1/2" male socket adapter, universal joint, 8" polished reversible ratchet, 3" and 6" extension bars. Plastic case. Easy grab "Grip Strips" on each socket - blue metric, red SAE.

Cat. No.	Description	Sale Price Each
BCQKTT-A3504SR	15 Piece Inch 3/8" Drive Socket Set	64.99
BCQKTT-A3504MR	15 Piece Metric 3/8" Drive Socket Set	64.99

Note: Lifetime Guarantee applies to individual tool items against failure when used under normal conditions. Guarantee does not apply to set cases.

FORKGRIPS

ForkGrips for Forklift and Truck Drivers

**Sale Price
Only
\$59⁹⁹**

New!



**Lifetime
guarantee**



- The safe and easy way to unload trucks when the forks barely reach the cargo
- Much lighter and less expensive than fork extensions and chains
- Reduce workman's comp. claims
- Keep employees safely off the truck
- No more damaged cargo
- Fit forks up to 6" wide
- Made in the U.S.A.

Cat. No.	Description	Sale Price Each
BCQAPA-14	Rubber Fork Grip	59.99

HAND CLEANER

Fast Orange® Lotion Hand Cleaner and Dispenser



**Sale Price
Only
\$15⁹⁹**

This petroleum free solvent formula cleans tough grease and grime with natural orange oil. Contains aloe, lanolin and jojoba to conditions skin. Leaves hands with a fresh scent of orange. Available in smooth lotion or pumice formula. USDA approved.

Cat. No.	Container	Sale Price Each
Fine Pumice Formula		
BCQLOC-25218	1 Gal. Bottle with Pump	15.99
BCQLOC-25104	1 Gal. Flat Top Bottle	15.99
Smooth Formula		
BCQLOC-23218	1 Gal. Bottle with Pump	15.99
Dispenser		
BCQLOC-95140	Pull Type, Wall Mount Dispenser	24.99

SCRUBS® IN-A-BUCKET®

Hand Cleaner Towels



**Expanded
Line**

**Buy in Case
Quantities and
Get a FREE Wall
Mount Bracket
(Shown Below)**

**Sale Price
As Low As
\$7²⁹**

- Proven way to clean your hands away from the sink
- SCRUBS® patented, dual-textured towels lock in dirt & will not transfer soils back onto hands
- Leave your hands clean, no rinsing necessary

**Save
More
Buy in Dozens
Discount 92 Applies**

Cat. No.	Description	Sale Price Each
BCQC-42230	Bucket of 30 Scrubs	7.29
BCQC-42230K	12 Buckets of 30 Scrubs with wall mount included	87.49
BCQC-422	Bucket of 72 Scrubs	11.99
BCQC-422K	12 Buckets of 72 Scrubs with wall mount included	143.88

92	Quantity	1-11	12-23	24-35	36+
Discount		Net	5%	10%	15%

Scrubs® in a Bucket® Wall Mount Bracket



**Sale Price
Only
\$9⁹⁹**

**Buy Scrubs
(shown above) in
Case Quantities
and Get Wall
Mount Bracket
FREE**

- Heavy duty steel construction
- Powder coat finish creates a rust resistant finish
- Can be mounted to virtually any flat surface (walls, vehicles, utility carts & more)
- Easy to install
- Accommodates SCRUBS IN-A-BUCKET® 30 & 72 count containers



Cat. No.	Description	Sale Price Each
BCQC-42293	Wall Mount Bucket Bracket	9.99

BATTERIES AND CHARGERS

Rechargeable Hybrid Pre-Charged



BCQ180371

Reid
green



BCQ180372

New!



BCQ180373

Battery Packs
Only \$12.99 Each

Rayovac Hybrid rechargeable batteries come pre-charged and ready to use. In addition to that, Hybrid battery technology takes NiMH batteries to a higher level. Hybrid batteries hold their charge significantly longer than standard NiMH batteries, when not in use. These convenient features along with the power to operate high drain devices provide a great product.

Chargers

Cat. No.	Description	Sale Price Each
BCQ180371	4 Position charger with 2 Hybrid™ AA	13.99

Rechargeable NiMH Batteries

Cat. No.	Description	Sale Price Each
BCQ180372	Low Discharge AA NiMH carded 4 pack	12.99
BCQ180373	Low Discharge AAA NiMH carded 4 pack	12.99

Rechargeable High Energy



New!

Battery Packs
As Low As \$7.99 Each

Reid
green

The Rayovac standard rechargeable line provides a full range of high energy NiMH batteries and chargers. Perfect for powering high drain devices. Rayovac High Energy rechargeable batteries provide a great value.

Chargers

Cat. No.	Description	Sale Price Each
BCQ180374	4-Battery Charger	13.99
BCQ180375	Universal Battery Charger	29.99

Rechargeable NiMH Batteries

Cat. No.	Description	Sale Price Each
BCQ180376	Rechargeable AA NiMH Carded 4 Pack	13.99
BCQ180377	Rechargeable AAA NiMH Carded 4 Pack	13.99
BCQ180378	Rechargeable C NiMH Carded 2 Pack	10.99
BCQ180379	Rechargeable D NiMH Carded 2 Pack	10.99
BCQ180380	Rechargeable 9V NiMH Carded 1 Pack	7.99



BCQ180374



BCQ180375



BCQ180376



BCQ180377

Ultra Pro



Batteries
As Low As \$8.99

New!



BCQ180381



BCQ180382



BCQ180383



BCQ180384



BCQ180385

Rayovac batteries are the #1 selling industrial battery based on top industrial distributors. Whether you need shrink packaging (great for contract or bid business) or contractor packaging to help organize and protect batteries from damage and short circuiting, Rayovac has a program to fit your needs.

Cat. No.	Description	Sale Price Each
BCQ180381	Alkaline AA Size Reclosable 24 Pack	12.49
BCQ180382	Alkaline AAA Size Reclosable 18 Pack	8.99
BCQ180383	Alkaline C Size Reclosable 12 Pack	11.49
BCQ180384	Alkaline D Size Reclosable 12 Pack	13.49
BCQ180385	Alkaline 9-Volt Reclosable 8 Pack	13.99

AIR GUNS

Jet Guard Safety Air Gun

- Delivers high thrust with pinpoint accuracy
- Safety air shield protects workers from chip fly-back
- Limits static pressure to 30 PSI when tip is blocked
- Knurled adjusting nut to control air volume
- 1/4" NPT inlet
- Maximum operating pressure 120 psi
- Cast aluminum pistol grip with hanging hook
- Meets OSHA standards



Cat. No. **BCQOG-5**
Sale Price
Only \$15⁹⁹

Whisper Jet Safety Air Gun

Cat. No. **BCQOG-6**
Sale Price
Only \$17⁹⁹



- Unique nozzle design reduces noise levels 6-20 dB less than conventional air guns
- Solid conical tip design prevents blockage of nozzle
- 1/4" NPT inlet
- Maximum operating pressure 150 psi
- Cast aluminum pistol grip with hanging hook
- Meets OSHA standards

Safety Tamperproof

- 1/4" FPT inlet
- Safety tip permanently attached to body
- Internal valve to keep pressure below 30 psi @ 150 psi
- Chrome plated castings

Cat. No. **BCQCOL-600ST**
Sale Price
Only \$7⁹⁹



Safety Booster Tip

Cat. No. **BCQCOL-600-SB**
Sale Price
Only \$7⁹⁹



- 1/4" FPT inlet
- Venturi holes maximize air volume
- Chrome plated casting
- Non-corrosive and leak proof
- Thumb lever control
- Lightweight



Premium Safety Tip and Extension

Sale Price
As Low As
\$7⁹⁹



Tough zinc die cast body with flat black powder coat finish and nickel plated tips combined for superior corrosion resistance. Ergonomic design and large operating lever reduce user fatigue and discomfort even during long term use. All come with safety tips.



Cat. No.	Description	Inlet	Replacement Nozzle	
			Sale Price Each	Sale Price Each
BCQCOL-600P-S	Standard	1/4 FPT	7.99	BCQCOL-ST10 1.99
BCQCOL-603P-S	3" Standard	1/4 FPT	12.99	BCQCOL-ST203 4.49

AIR TOOL LUBRICANT

Sale Price
As Low As
\$3⁹⁹



Coilhoose Pneumatics® air tool lubricant is a specially formulated high grade 10 weight lubricant. Prolongs the service life of air tools, cylinders and accessories while allowing maximum performance. Rust proofs while removing moisture. Non-detergent, non-corrosive, non-reactive and stable. Provides superior performance over ordinary lubricants.



Cat. No.	Description	Sale Price Each
BCQCOL-ATL0616	Pint Bottle	3.99
BCQCOL-ATL032	Quart Bottle	5.99
BCQCOL-ATL128	Gallon Bottle	19.99

TOOL BALANCERS

Mechanical Tool Balancers



Sale Price
As Low As
\$64⁹⁵



- Tension adjustment
- Adjustable rubber stop
- Nylon cable
- Permanently lubricated

Cat. No.	Working Range (Lbs.)	Cable Length	Sale Price Each
BCQCOL-BL02	1 - 3.5	8'	64.95
BCQCOL-BL05	2 - 4.5	8'	69.95
BCQCOL-BL08	4.5 - 8.0	8'	72.95
BCQCOL-BL10	6.5 - 13.5	8'	119.95

CYLINDERS

Interchangeable Tie Rod Cylinders



Sale Price As Low As \$65⁹⁵

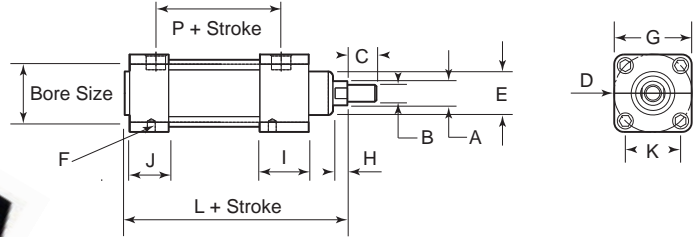

Medium duty, double acting, tie rod cylinders are NFPA interchangeable. Cylinders come standard with magnetic piston, adjustable cushion and add-a-mount construction. Pre-lubricated, minimum 7 psi, maximum 140 psi operating pressure. Other strokes, mounts and sizes available as special order. Please call for price and delivery.

Mounting Brackets with Bolts

Bore Size	Flange Type				Clevis Type			
	Cat. No.	Price Each	Cat. No.	Price Each	Cat. No.	Price Each	Cat. No.	Price Each
1 1/2	BCQRFM-150	7.49	BCQCPM-150	8.99				
2	BCQRFM-2	8.89	BCQCPM-2	9.99				
2 1/2	BCQRFM-250	11.95	BCQCPM-250	12.99				
3 1/4	BCQRFM-325	13.95	BCQCPM-325	13.99				
4	BCQRFM-4	14.95	BCQCPM-4	17.99				

Cat. No.	Bore Size	Stroke	A	B	C	D	E	F	G	H	I	J	K	L	P	Sale Price Each
BCQTRC150-1	1 1/2	1	5/8	7/16-20	3/4	2.02	1.124	1/4-28	2	3/8	1.26	1.01	1.43	4 3/4	2.36	65.95
BCQTRC150-2	1 1/2	2	5/8	7/16-20	3/4	2.02	1.124	1/4-28	2	3/8	1.26	1.01	1.43	4 3/4	2.36	67.95
BCQTRC150-3	1 1/2	3	5/8	7/16-20	3/4	2.02	1.124	1/4-28	2	3/8	1.26	1.01	1.43	4 3/4	2.36	69.95
BCQTRC150-4	1 1/2	4	5/8	7/16-20	3/4	2.02	1.124	1/4-28	2	3/8	1.26	1.01	1.43	4 3/4	2.36	71.95
BCQTRC150-5	1 1/2	5	5/8	7/16-20	3/4	2.02	1.124	1/4-28	2	3/8	1.26	1.01	1.43	4 3/4	2.36	73.95
BCQTRC150-6	1 1/2	6	5/8	7/16-20	3/4	2.02	1.124	1/4-28	2	3/8	1.26	1.01	1.43	4 3/4	2.36	75.95
BCQTRC150-8	1 1/2	8	5/8	7/16-20	3/4	2.02	1.124	1/4-28	2	3/8	1.26	1.01	1.43	4 3/4	2.36	79.95
BCQTRC150-10	1 1/2	10	5/8	7/16-20	3/4	2.02	1.124	1/4-28	2	3/8	1.26	1.01	1.43	4 3/4	2.36	83.95
BCQTRC150-12	1 1/2	12	5/8	7/16-20	3/4	2.02	1.124	1/4-28	2	3/8	1.26	1.01	1.43	4 3/4	2.36	88.95
BCQTRC150-14	1 1/2	14	5/8	7/16-20	3/4	2.02	1.124	1/4-28	2	3/8	1.26	1.01	1.43	4 3/4	2.36	92.95
BCQTRC150-16	1 1/2	16	5/8	7/16-20	3/4	2.02	1.124	1/4-28	2	3/8	1.26	1.01	1.43	4 3/4	2.36	96.95
BCQTRC150-18	1 1/2	18	5/8	7/16-20	3/4	2.02	1.124	1/4-28	2	3/8	1.26	1.01	1.43	4 3/4	2.36	99.95
BCQTRC150-20	1 1/2	20	5/8	7/16-20	3/4	2.02	1.124	1/4-28	2	3/8	1.26	1.01	1.43	4 3/4	2.36	104.95
BCQTRC2-1	2	1	5/8	7/16-20	3/4	2.60	1.124	5/16-24	2 1/2	3/8	1.26	1.06	1.84	4 3/4	2.40	69.95
BCQTRC2-2	2	2	5/8	7/16-20	3/4	2.60	1.124	5/16-24	2 1/2	3/8	1.26	1.06	1.84	4 3/4	2.40	72.95
BCQTRC2-3	2	3	5/8	7/16-20	3/4	2.60	1.124	5/16-24	2 1/2	3/8	1.26	1.06	1.84	4 3/4	2.40	75.95
BCQTRC2-4	2	4	5/8	7/16-20	3/4	2.60	1.124	5/16-24	2 1/2	3/8	1.26	1.06	1.84	4 3/4	2.40	78.95
BCQTRC2-5	2	5	5/8	7/16-20	3/4	2.60	1.124	5/16-24	2 1/2	3/8	1.26	1.06	1.84	4 3/4	2.40	79.95
BCQTRC2-6	2	6	5/8	7/16-20	3/4	2.60	1.124	5/16-24	2 1/2	3/8	1.26	1.06	1.84	4 3/4	2.40	82.95
BCQTRC2-8	2	8	5/8	7/16-20	3/4	2.60	1.124	5/16-24	2 1/2	3/8	1.26	1.06	1.84	4 3/4	2.40	87.95
BCQTRC2-10	2	10	5/8	7/16-20	3/4	2.60	1.124	5/16-24	2 1/2	3/8	1.26	1.06	1.84	4 3/4	2.40	91.95
BCQTRC2-12	2	12	5/8	7/16-20	3/4	2.60	1.124	5/16-24	2 1/2	3/8	1.26	1.06	1.84	4 3/4	2.40	96.95
BCQTRC2-14	2	14	5/8	7/16-20	3/4	2.60	1.124	5/16-24	2 1/2	3/8	1.26	1.06	1.84	4 3/4	2.40	99.95
BCQTRC2-16	2	16	5/8	7/16-20	3/4	2.60	1.124	5/16-24	2 1/2	3/8	1.26	1.06	1.84	4 3/4	2.40	104.95
BCQTRC2-18	2	18	5/8	7/16-20	3/4	2.60	1.124	5/16-24	2 1/2	3/8	1.26	1.06	1.84	4 3/4	2.40	109.95
BCQTRC2-20	2	20	5/8	7/16-20	3/4	2.60	1.124	5/16-24	2 1/2	3/8	1.26	1.06	1.84	4 3/4	2.40	114.95
BCQTRC2-24	2	24	5/8	7/16-20	3/4	2.60	1.124	5/16-24	2 1/2	3/8	1.26	1.06	1.84	4 3/4	2.40	123.95
BCQTRC250-1	2 1/2	1	5/8	7/16-20	3/4	3.10	1.124	5/16-24	3	3/8	1.30	1.06	2.19	4 8/7	2.48	78.95
BCQTRC250-2	2 1/2	2	5/8	7/16-20	3/4	3.10	1.124	5/16-24	3	3/8	1.30	1.06	2.19	4 8/7	2.48	79.95
BCQTRC250-3	2 1/2	3	5/8	7/16-20	3/4	3.10	1.124	5/16-24	3	3/8	1.30	1.06	2.19	4 8/7	2.48	82.95
BCQTRC250-4	2 1/2	4	5/8	7/16-20	3/4	3.10	1.124	5/16-24	3	3/8	1.30	1.06	2.19	4 8/7	2.48	84.95
BCQTRC250-5	2 1/2	5	5/8	7/16-20	3/4	3.10	1.124	5/16-24	3	3/8	1.30	1.06	2.19	4 8/7	2.48	87.95
BCQTRC250-6	2 1/2	6	5/8	7/16-20	3/4	3.10	1.124	5/16-24	3	3/8	1.30	1.06	2.19	4 8/7	2.48	89.95
BCQTRC250-8	2 1/2	8	5/8	7/16-20	3/4	3.10	1.124	5/16-24	3	3/8	1.30	1.06	2.19	4 8/7	2.48	94.95
BCQTRC250-10	2 1/2	10	5/8	7/16-20	3/4	3.10	1.124	5/16-24	3	3/8	1.30	1.06	2.19	4 8/7	2.48	99.95
BCQTRC250-12	2 1/2	12	5/8	7/16-20	3/4	3.10	1.124	5/16-24	3	3/8	1.30	1.06	2.19	4 8/7	2.48	104.95
BCQTRC250-14	2 1/2	14	5/8	7/16-20	3/4	3.10	1.124	5/16-24	3	3/8	1.30	1.06	2.19	4 8/7	2.48	109.95
BCQTRC250-16	2 1/2	16	5/8	7/16-20	3/4	3.10	1.124	5/16-24	3	3/8	1.30	1.06	2.19	4 8/7	2.48	114.95
BCQTRC250-18	2 1/2	18	5/8	7/16-20	3/4	3.10	1.124	5/16-24	3	3/8	1.30	1.06	2.19	4 8/7	2.48	119.95
BCQTRC250-20	2 1/2	20	5/8	7/16-20	3/4	3.10	1.124	5/16-24	3	3/8	1.30	1.06	2.19	4 8/7	2.48	124.95
BCQTRC250-24	2 1/2	24	5/8	7/16-20	3/4	3.10	1.124	5/16-24	3	3/8	1.30	1.06	2.19	4 8/7	2.48	134.95
BCQTRC325-1	3 1/4	1	1	3/4-16	1 1/8	3.90	1.499	3/8-24	3 3/4	1/2	1.57	1.18	2.76	5 53/64	2.72	118.95
BCQTRC325-2	3 1/4	2	1	3/4-16	1 1/8	3.90	1.499	3/8-24	3 3/4	1/2	1.57	1.18	2.76	5 53/64	2.72	124.95
BCQTRC325-3	3 1/4	3	1	3/4-16	1 1/8	3.90	1.499	3/8-24	3 3/4	1/2	1.57	1.18	2.76	5 53/64	2.72	127.95
BCQTRC325-4	3 1/4	4	1	3/4-16	1 1/8	3.90	1.499	3/8-24	3 3/4	1/2	1.57	1.18	2.76	5 53/64	2.72	132.95
BCQTRC325-5	3 1/4	5	1	3/4-16	1 1/8	3.90	1.499	3/8-24	3 3/4	1/2	1.57	1.18	2.76	5 53/64	2.72	136.95
BCQTRC325-6	3 1/4	6	1	3/4-16	1 1/8	3.90	1.499	3/8-24	3 3/4	1/2	1.57	1.18	2.76	5 53/64	2.72	139.95
BCQTRC325-8	3 1/4	8	1	3/4-16	1 1/8	3.90	1.499	3/8-24	3 3/4	1/2	1.57	1.18	2.76	5 53/64	2.72	145.95
BCQTRC325-10	3 1/4	10	1	3/4-16	1 1/8	3.90	1.499	3/8-24	3 3/4	1/2	1.57	1.18	2.76	5 53/64	2.72	152.95
BCQTRC325-12	3 1/4	12	1	3/4-16	1 1/8	3.90	1.499	3/8-24	3 3/4	1/2	1.57	1.18	2.76	5 53/64	2.72	157.95
BCQTRC325-14	3 1/4	14	1	3/4-16	1 1/8	3.90	1.499	3/8-24	3 3/4	1/2	1.57	1.18	2.76	5 53/64	2.72	164.95
BCQTRC325-16	3 1/4	16	1	3/4-16	1 1/8	3.90	1.499	3/8-24	3 3/4	1/2	1.57	1.18	2.76	5 53/64	2.72	169.95
BCQTRC325-18	3 1/4	18	1	3/4-16	1 1/8	3.90	1.499	3/8-24	3 3/4	1/2	1.57	1.18	2.76	5 53/64	2.72	175.95
BCQTRC325-20	3 1/4	20	1	3/4-16	1 1/8	3.90	1.499	3/8-24	3 3/4	1/2	1.57	1.18	2.76	5 53/64	2.72	182.95
BCQTRC325-24	3 1/4	24	1	3/4-16	1 1/8	3.90	1.499	3/8-24	3 3/4	1/2	1.57	1.18	2.76	5 53/64	2.72	194.95
BCQTRC4-1	4	1	1	3/4-16	1 1/8	4.70	1.499	3/8-24	4 1/2	1/2	1.57	1.18	3.32	5 53/64	2.72	136.95
BCQTRC4-2	4	2	1	3/4-16	1 1/8	4.70	1.499	3/8-24	4 1/2	1/2	1.57	1.18	3.32	5 53/64	2.72	140.95
BCQTRC4-3	4	4	1	3/4-16	1 1/8	4.70	1.499	3/8-24	4 1/2	1/2	1.57	1.18	3.32	5 53/64	2.72	145.95
BCQTRC4-4	4	4	1	3/4-16	1 1/8	4.70	1.499	3/8-24	4 1/2	1/2	1.57	1.18	3.32	5 53/64	2.72	147.95
BCQTRC4-5	4	5	1	3/4-16	1 1/8	4.70	1.499	3/8-24	4 1/2	1/2	1.57	1.18	3.32	5 53/64	2.72	152.95
BCQTRC4-6	4	6	1	3/4-16	1 1/8	4.70	1.499	3/8-24	4 1/2	1/2	1.57	1.18	3.32	5 53/64	2.72	156.95
BCQTRC4-8	4	8	1	3/4-16	1 1/8	4.70	1.499	3/8-24	4 1/2	1/2	1.57	1.18	3.32	5 53/64	2.72	162.95
BCQTRC4-10	4	10	1	3/4-16	1 1/8	4.70	1.499	3/8-24	4 1/2	1/2	1.57	1.18	3.32	5 53/64	2.72	169.95
BCQTRC4-12	4	12	1	3/4-16	1 1/8	4.70	1.499	3/8-24	4 1/2	1/2	1.57	1.18	3.32	5 53/64	2.72	176.95
BCQTRC4-14	4	14	1	3/4-16	1 1/8	4.70	1.499	3/8-24	4 1/2	1/2	1.57	1.18	3.32	5 53/64	2.72	184.95
BCQTRC4-16	4	16	1	3/4-16	1 1/8	4.70	1.499	3/8-24	4 1/2	1/2	1.57	1.18	3.32	5 53/64	2.72	192.95
BCQTRC4-18	4	18	1	3/4-16	1 1/8	4.70	1.499	3/8-24	4 1/2	1/2	1.57	1.18	3.32	5 53/64	2.72	199.95
BCQTRC4-20	4	20														

INDUSTRIAL HYDRAULICS

Air Hydraulic Pump

ENERPAC®

Sale Price
Only
\$525⁹⁵

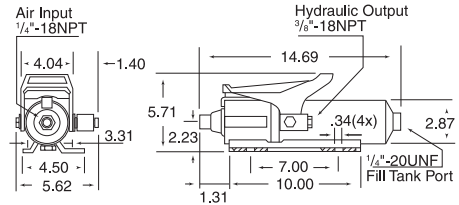

Rugged construction for long life and easy service. Swivel coupling simplifies hydraulic connection and pump operation. Three position treadle provides cylinder advance, hold or retract operation. Operates in all positions for increased versatility in use and mounting. Base mounting slots provided. See page 147 of our 2009 Full Line Catalog for other pumps.

Cat. No.	Enerpac	Used With Cylinder	Useable Oil Capacity (In. ³)	Pressure Rating (PSI)	Output Flow Rate (In. ³ /Min.)		Valve Function	Air Pressure Range (PSI)	Air Consumption (scfm)	Sound Level (dBA)	Sale Price Each
					No Load	Load					
BCQEH-110	PA-133	Single Acting	36	10,000	40	8	Advance/Hold/Retract	40-100	9	85	525.95

Light Weight Hand Pumps

Sale Price
As Low As **\$304⁹⁵**

ENERPAC®

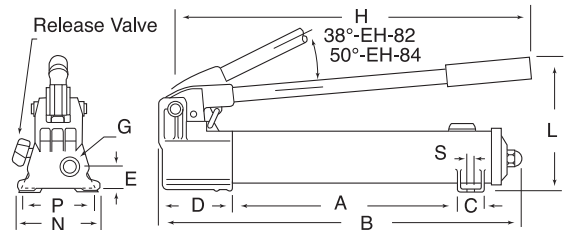

These compact pumps have a two speed operation to reduce operator fatigue. The pump base is made of nylon encapsulated aluminum and the reservoir is made of glass filled nylon for resistance to corrosion. The handle is made of non-conductive fiberglass and locks for easy carrying. There is an internal pressure relief valve for overload protection. See page 147 of our 2009 Full Line Catalog for other pumps.

Cat. No.	Enerpac	Useable Oil Capacity (In. ³)	Pressure Rating (PSI)		Oil Displacement Per Stroke (In. ³)		Max. Handle Effort (Lbs.)	Piston Stroke (In.)	Dimensions (In.)											Sale Price Each
			1st Stage	2nd Stage	1st Stage	2nd Stage			A	B	C	D	E	G	H	L	N	P	S	
BCQEH-82	P-142	20	200	10,000	.221	.055	78	.50	7.31	13.25	1.13	3.37	1.13	1/4-18	12.56	5.63	3.75	3.18	.28	304.95
BCQEH-84	P-392	55	200	10,000	.687	.151	93	1.00	13.56	21.00	1.44	3.93	1.31	3/8-18	20.56	7.00	4.75	—	—	339.95

Hydraulic Wedge and Spread Cylinder

ENERPAC®

Sale Price
Only
\$243⁹⁵

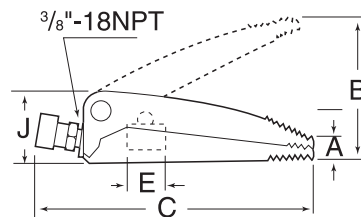

For use in very confined work areas. Compact design allows cylinder to be wedged into tight areas and then can be spread to position or hold. Maximum operating pressure 10,000 psi. Maximum stroke is 11-1/2".

Cat. No.	Enerpac	Cylinder Capacity (Tons)	Tip Clearance	Cylinder Effect Area (In. ²)	Oil Capacity (In. ³)	Dimensions (In.)				Wedge Width	Sale Price Each	
						A	B	C	E			J
BCQEH-112	WR-5	1.00	.38	1.00	61	38	3.70	8.78	1.13	2.01	2.01	243.95



Speediest Install Time

Hollaender, Your Handrail Source

Safety is always the priority in a manufacturing or industrial setting. Hollaender pipe fittings provide a strong, durable safety rail that can easily be reconfigured. There's no welding or threading making installation quick and simple for your standard maintenance personnel.

Hollaender
O.S.H.A. COMPLIANT

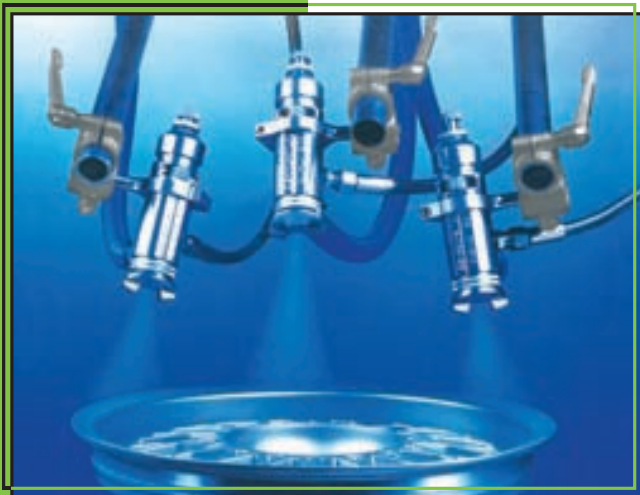

One System – Multiple Applications

This clamp and tube connection system can be configured using an infinite variety of sizes, shapes and clamp features, which offers a degree of flexibility that makes it beneficial to virtually all industries. Some of these industries include production assembly, all areas of material handling, mechanical engineering, OEM machinery design and the automotive and paper industries. They may also be used in applications like food packaging and beverage and chemical processing.

**COMPONENTS AND
SYSTEM SOLUTIONS
FOR HIGHEST
DEMANDS**

RK ROSE+KRIEGER

A Phoenix Mecano Company

Vulcan® Hard Hats

HARD HATS AND ACCESSORIES



Sale Price
As Low As **\$4⁸⁹**



Full Brim



Squeeze Lock



Ratchet Suspension

The Vulcan's construction features a rain trough, universal accessory slots, eyelets for affixing chin strap and embossed date of manufacture. Inside, the Vulcan hard hat features an ultra soft yet strong, super comfortable, 6 point woven nylon web - crown strap system that acts as a rugged shock absorber with six load-bearing points to spread impact over a larger area, and stabilize the hard hat. Choose from "Squeeze Lock" or ratchet suspension adjustments. Included FREE with suspension - a detachable plush cotton terry, laminated over soft foam, front sweatband to enhance comfort and snug sizing without leaving marks on forehead. The full brim model displays metric tables and celsius/fahrenheit temperature conversion charts under the brim.

Cat. No.	Description	Color	Sale Price Each
BCQ1840733	Hard Hat w/"Squeeze Lock" Suspension	Blue	4.89
BCQ1840734	Hard Hat w/"Squeeze Lock" Suspension	White	4.89
BCQ1840735	Hard Hat w/"Squeeze Lock" Suspension	Red	4.89
BCQ1840736	Hard Hat w/"Squeeze Lock" Suspension	Yellow	4.89
BCQ1840737	Hard Hat w/Ratchet Suspension	Blue	8.49
BCQ1840738	Hard Hat w/Ratchet Suspension	White	8.49
BCQ1840739	Hard Hat w/Ratchet Suspension	Red	8.49
BCQ1840740	Hard Hat w/Ratchet Suspension	Yellow	8.49
BCQ1840741	Full Brim w/Ratchet Suspension	Blue	8.99
BCQ1840742	Full Brim w/Ratchet Suspension	White	8.99
BCQ1840743	Full Brim w/Ratchet Suspension	Red	8.99
BCQ1840744	Full Brim w/Ratchet Suspension	Yellow	8.99

MiraCool® Hard Hat Pad Insert

- Use your head to stay cool with MiraCool® hard hat inserts
- Just minutes in cool water, then fasten to hard hat suspension
- Air movement around the suspension enhances cooling evaporation
- Does not interfere with any hard hat safety standards



Sale Price
Only **\$3⁴⁹**

Cat. No.	Description	Sale Price Each
BCQ1815019	Hard Hat Pad	3.49

MIRACOO® BANDANAS



- Soak MiraCool® in cold water for 10-20 minutes
- Stays hydrated for several days
- Reusable thousands of times
- Works without freezing or ice
- Increases alertness and productivity
- Ideal for factory, construction and laundry room workers, welders, painters, chefs or anyone working or playing in a warm environment - indoors or out.
- Deluxe - longer, wider, holds more cooling water than regular bandana

Sale Price
Only **\$2¹⁹**

Cat. No.	Description	Color	Sale Price Each
BCQ1815011	Deluxe Bandana	Cowboy Red	2.19
BCQ1815012	Deluxe Bandana	Cowboy Blue	2.19
BCQ1815013	Deluxe Bandana	Jungle Flage	2.19
BCQ1815014	Deluxe Bandana	Desert Flage	2.19

SAFETY GLASSES

Crews Checklite®



- Features exclusive Duramass® scratch resistant and Duramass® anti-fog lens coating
- Strong, lightweight polycarbonate lens filters out 99.9% of U.V. radiation
- Near total seal of eye orbit assures the highest level of protection
- Flexible spatula temple design for a comfortable fit during long use
- Meets or exceeds ANSI Z87.1 safety standards

Sale Price
As Low As **99¢**



Clear Coated Lens/
Clear Frame

Cat. No.	Lens Color	Frame Color	Sale Price Each
BCQ1840668	Clear Coated	Clear	.99
BCQ1840669	Grey	Smoke	.99
BCQ1840670	Indoor/Outdoor Mirror	Clear	1.49

HEARING PROTECTION

Moldex Jazz Band®



Sale Price
Only **\$4⁴⁹**

- A comfortable alternative to muffs
- Optional breakaway neck cord allows the Jazz Band® to conveniently hang around the neck when not in use
- Won't interfere with safety glasses
- Exclusive AdB® coating makes pods soil-resistant
- Spare pods included in each package
- Replacement package contains five pair pods and one neck cord per bag
- NRR 25 (under the chin)

Cat. No.	Description	NRR	Quantity	Sale Price Each
BCQ1840771	Jazz Band®	25	1	4.49
BCQ1840682	Replacement Pods w/Neck Cord	-	5 pairs	1.89

Postmaster please deliver between 4/24/09 — 5/1/09

Mailroom: If the addressee is no longer at this address, please email to mail@ReidSupply.com or fax corrections to 800.438.1145.

Customer #	Contact ID

Re-route to:

- Engineering
- Tool Room
- Purchasing



Reid Customer Service is here to help you, Monday through Friday from 7 a.m. to 8 p.m. EST.

PRINTED IN THE USA 9-02-05-03 Promo Code BCQ

Reid Supply Company®

SAVINGS SPOTLIGHT

Prices Effective May 1 - June 30, 2009

Pressure Adjusting Spring Clamps
As Low As **\$2.99**

Page 3

Digital Micrometers
As Low As **\$59.99**

Page 7

Grinding Wheels
Save More Than **10%**

Page 7

Radiae Abrasives

Socket Sets Only
\$64.99

Page 9

New!

KT PRO

Battery Chargers Only
\$13.99

Page 10

NiMH Battery Packs \$12.99

New!

RAYOVAC Hybrid